



# Ilusiones ópticas imposibles





**¿Qué ves: columnas cuadradas o redondas? ¿Cuántas?**

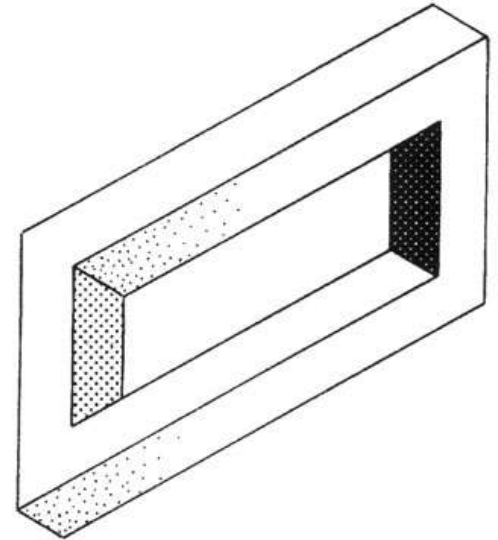
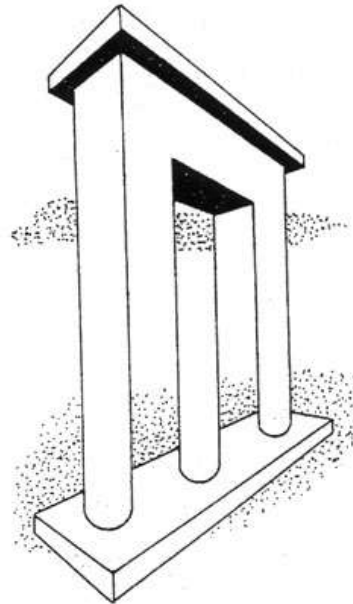
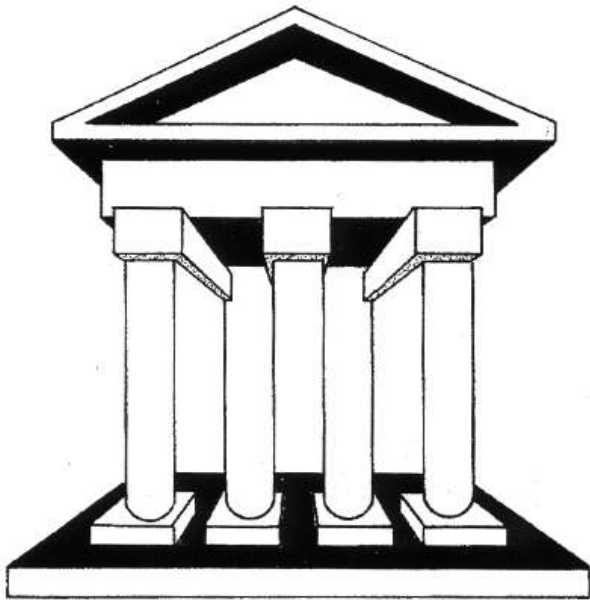

**Columnas ambiguas...**

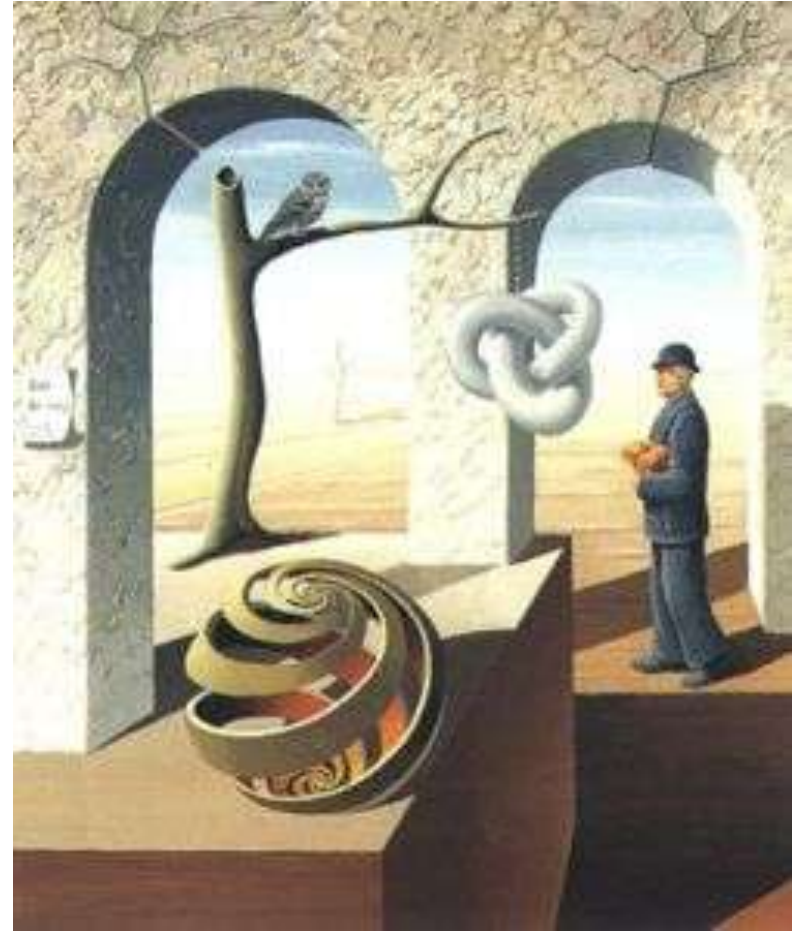

**Columnas ambiguas...**

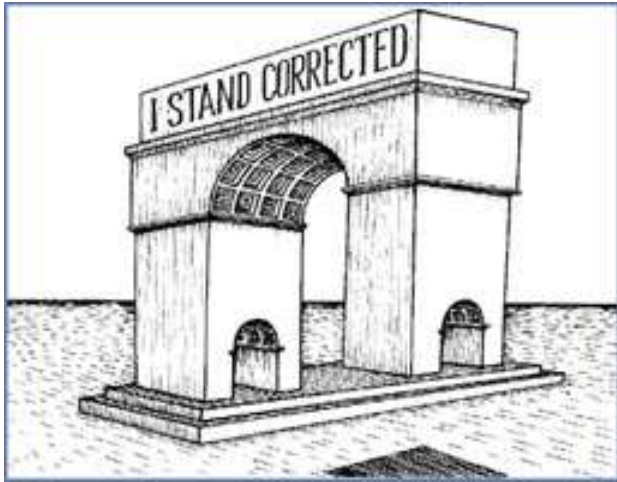

**Columnas ambiguas...**



**Geometría difícil...**

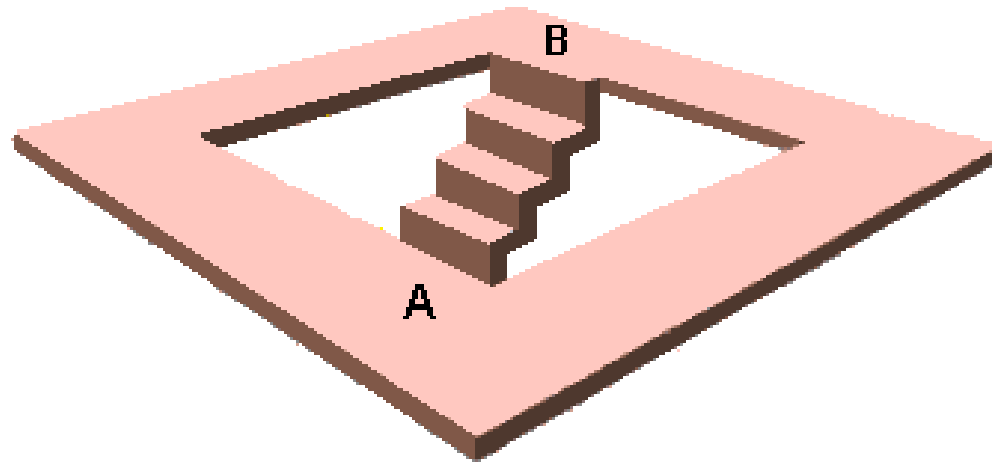

**Extrañas escaleras...**

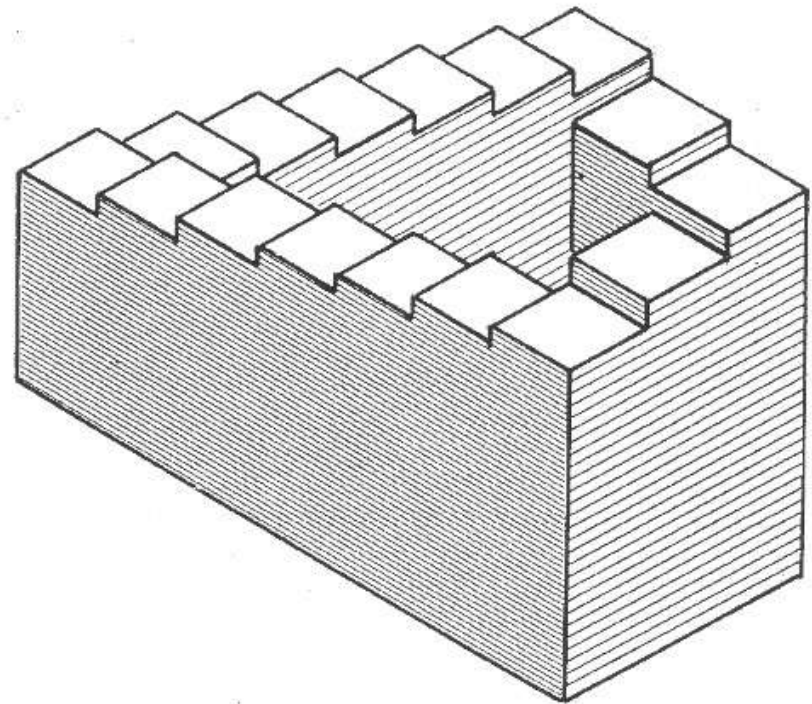
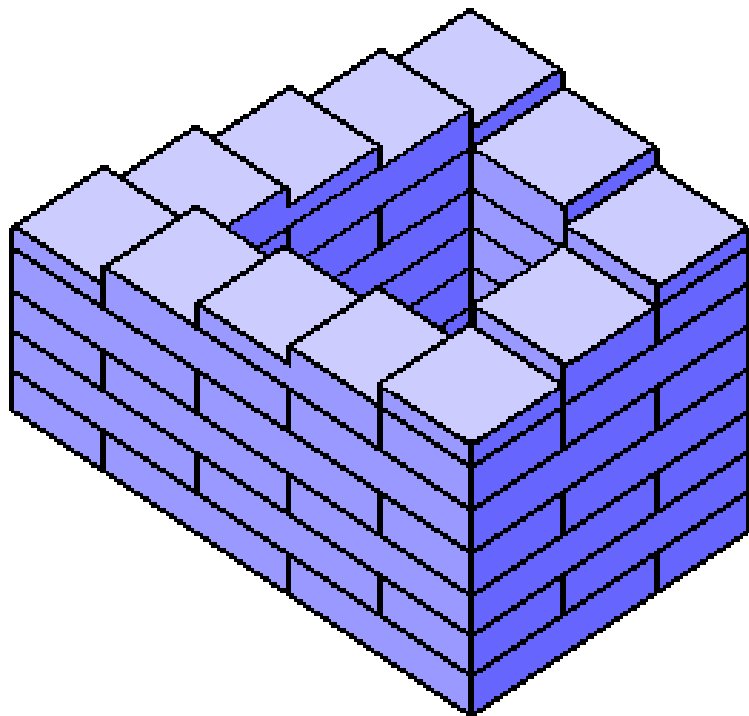

**Escaleras sin fin...**



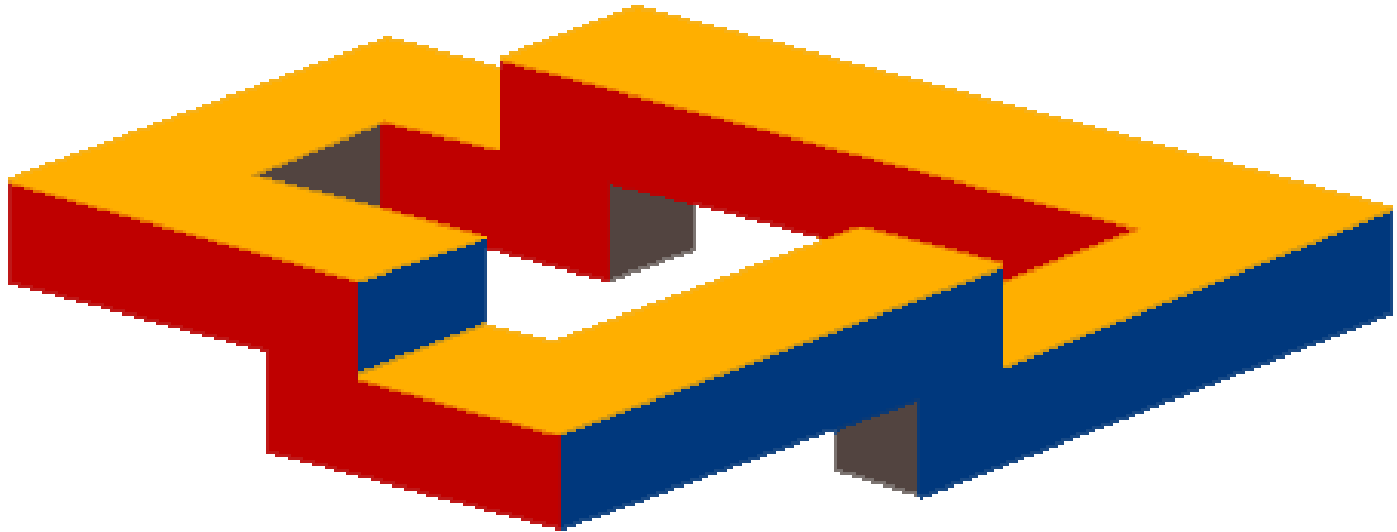

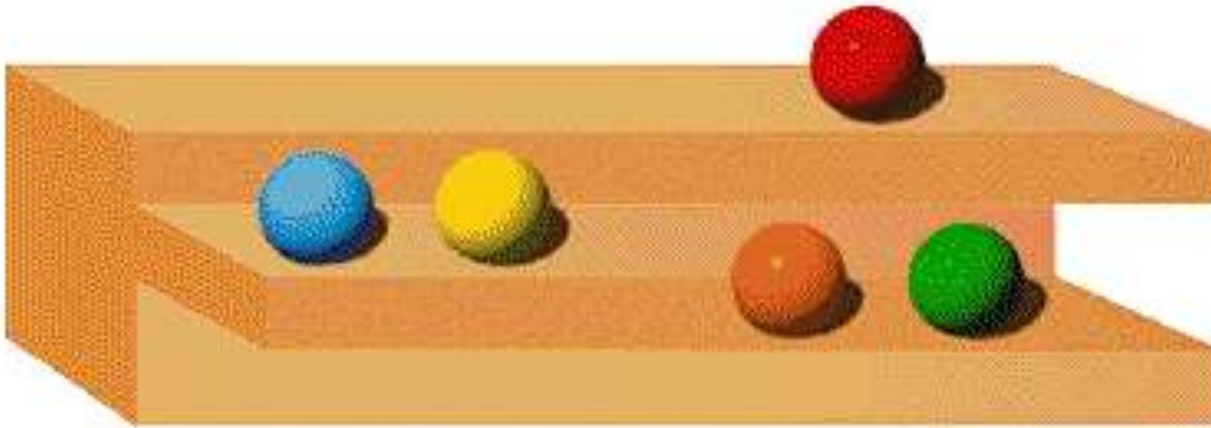

**¿Cuántas tablas ves aquí?...**

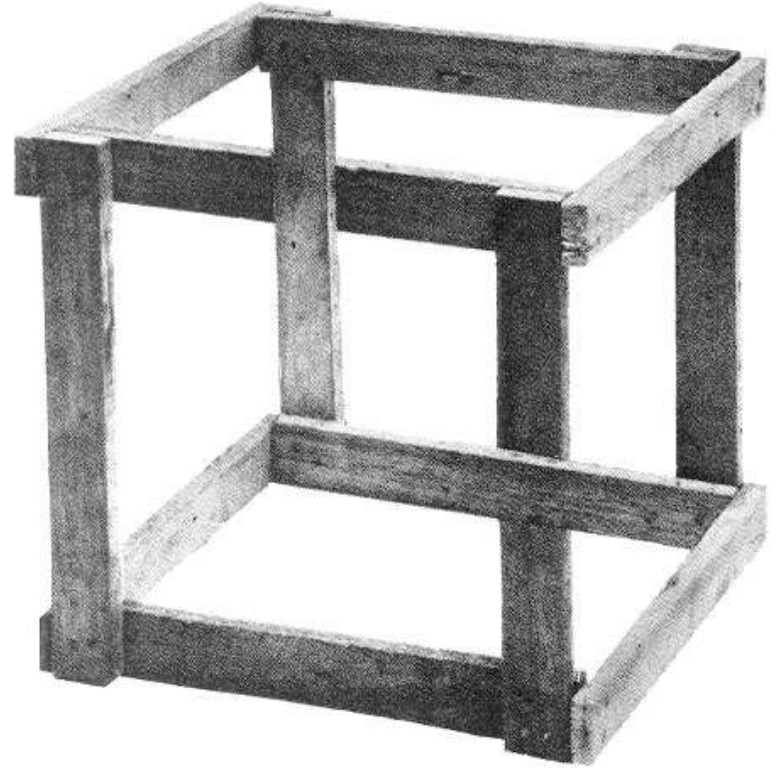
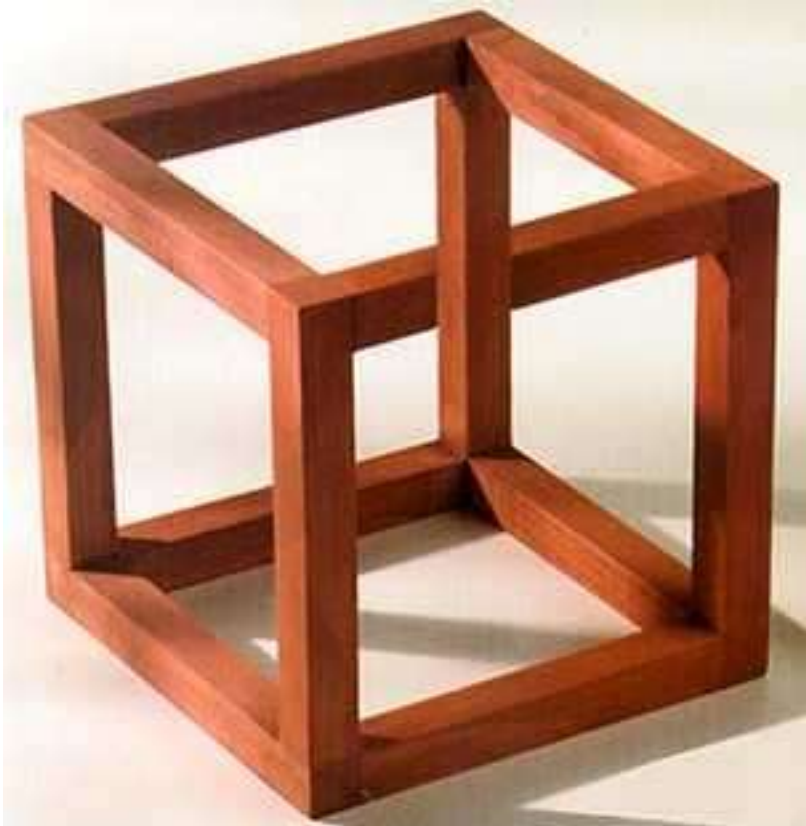

**Cubos imposibles**

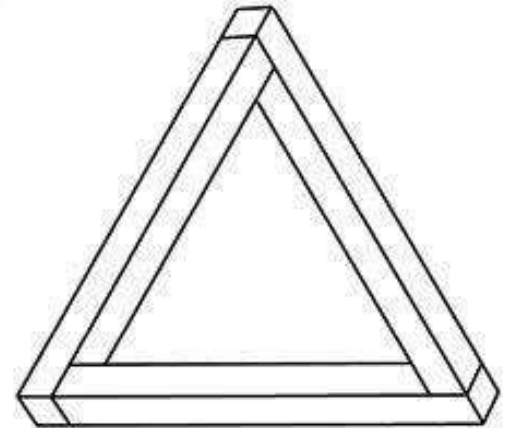
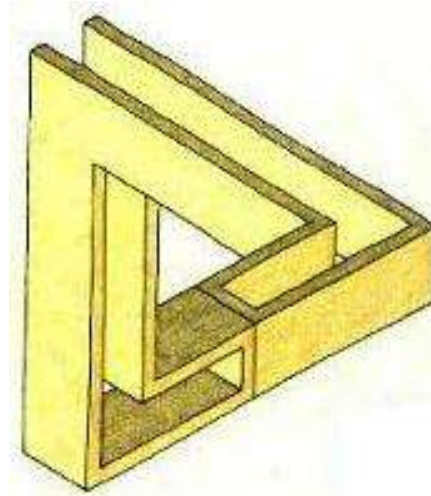
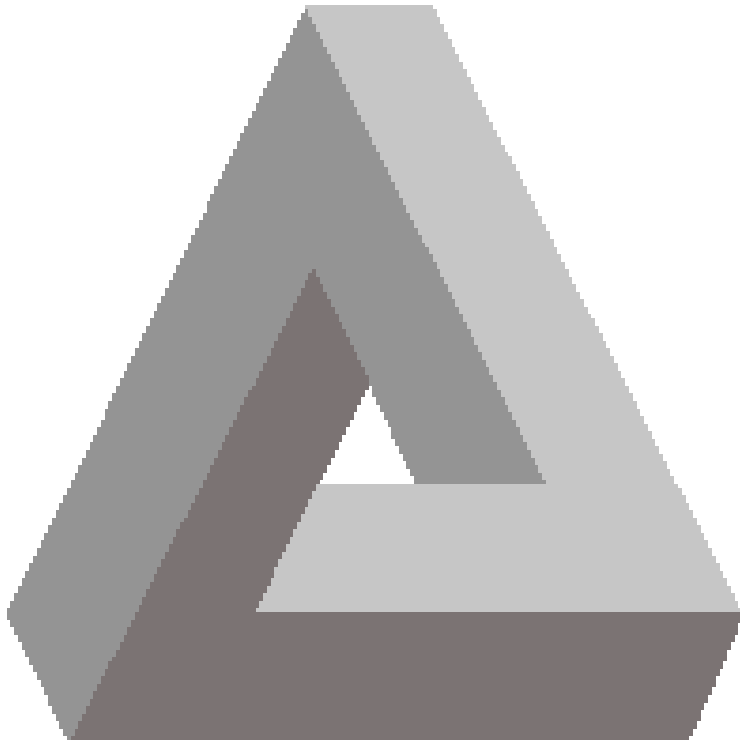

**Triángulos imposibles**

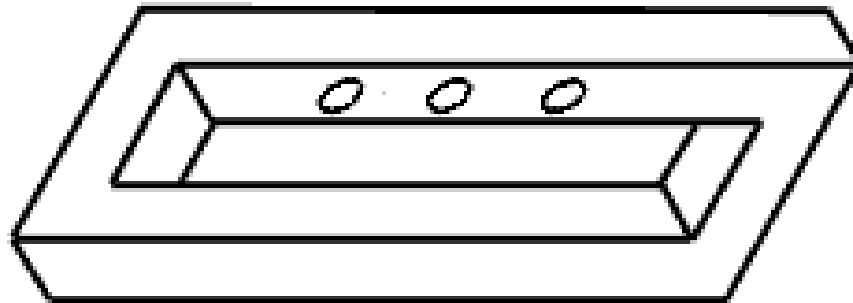

**¿Los círculos están dentro o fuera?**

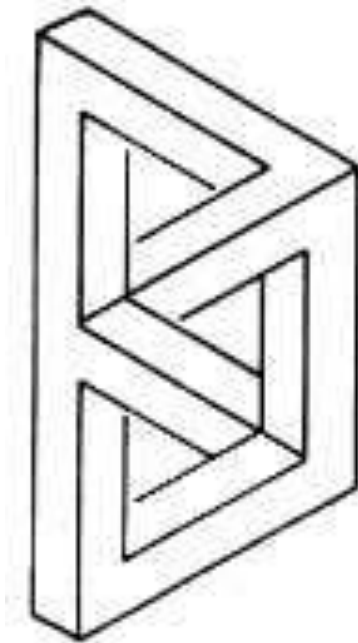

**Extraña cascada...**

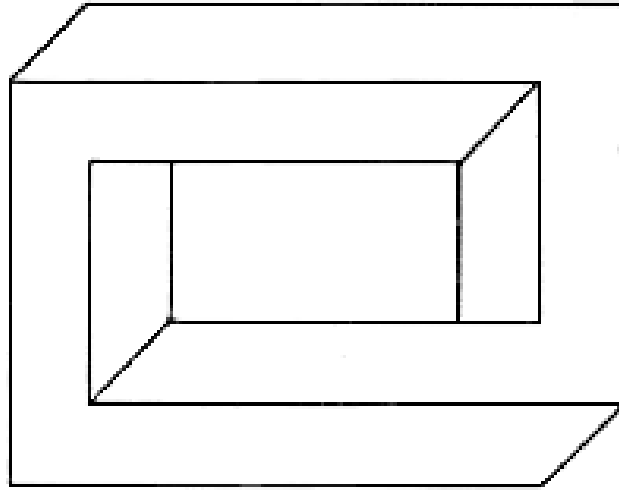

**Un cuadrilátero muy raro...**

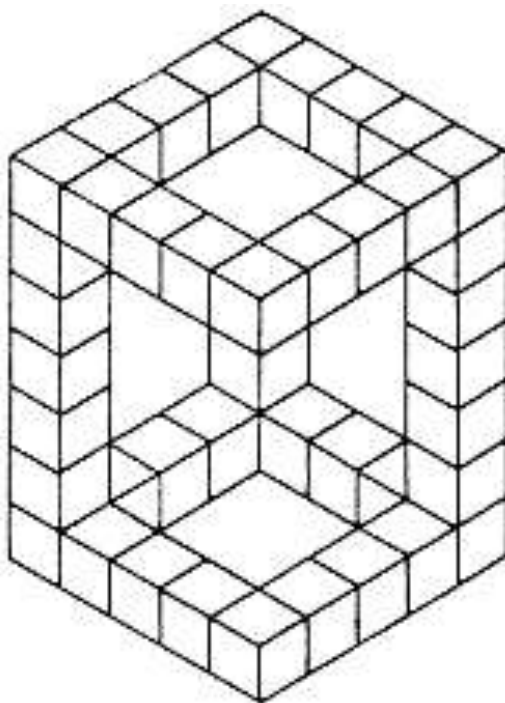

**Cuboide, o sea, un cubo que no es un cubo.  
¿O sí lo es?...**



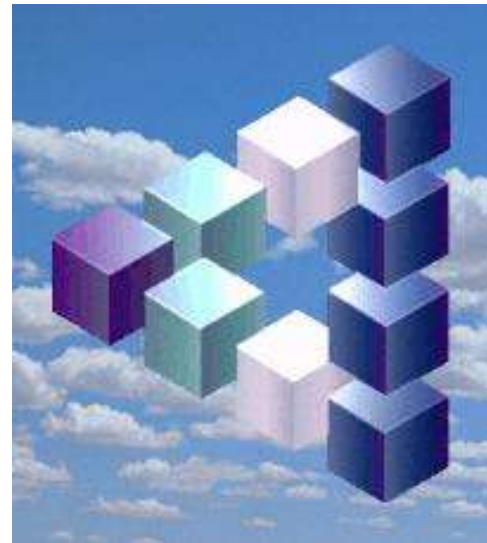
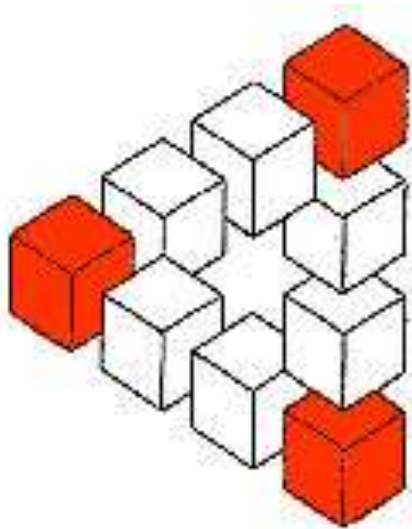

**Triângulo imposible**

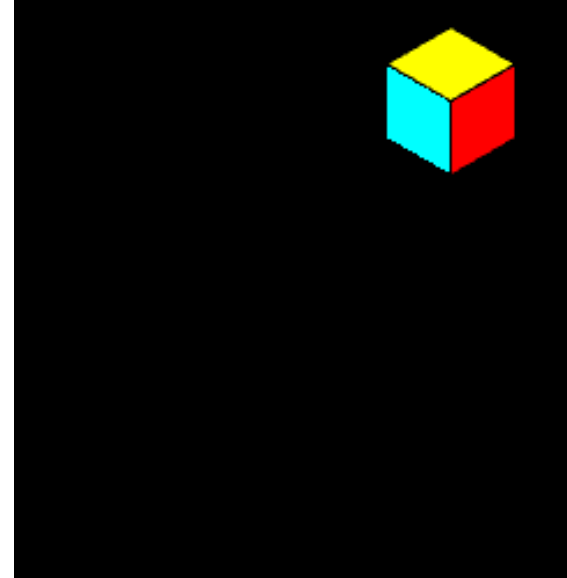
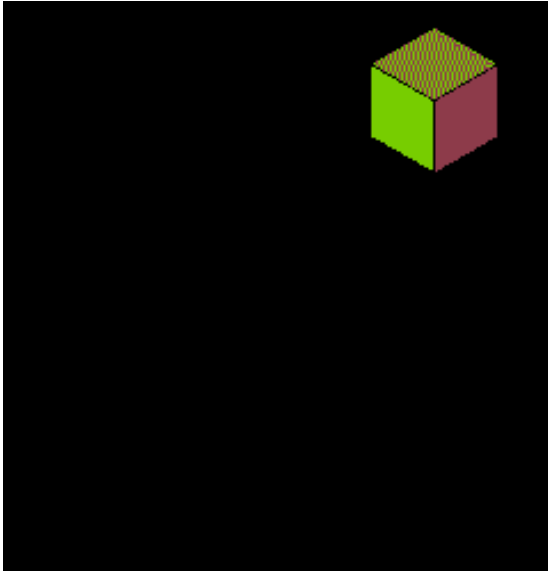

**¿Qué camino siguen los cubos en su recorrido?  
¿Qué cubo está delante?**

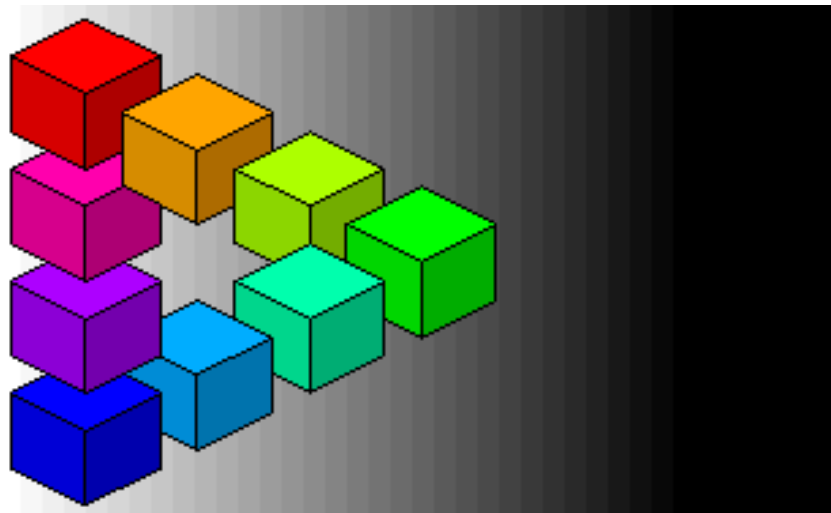



**¿Que ves: una terraza o un techo?**

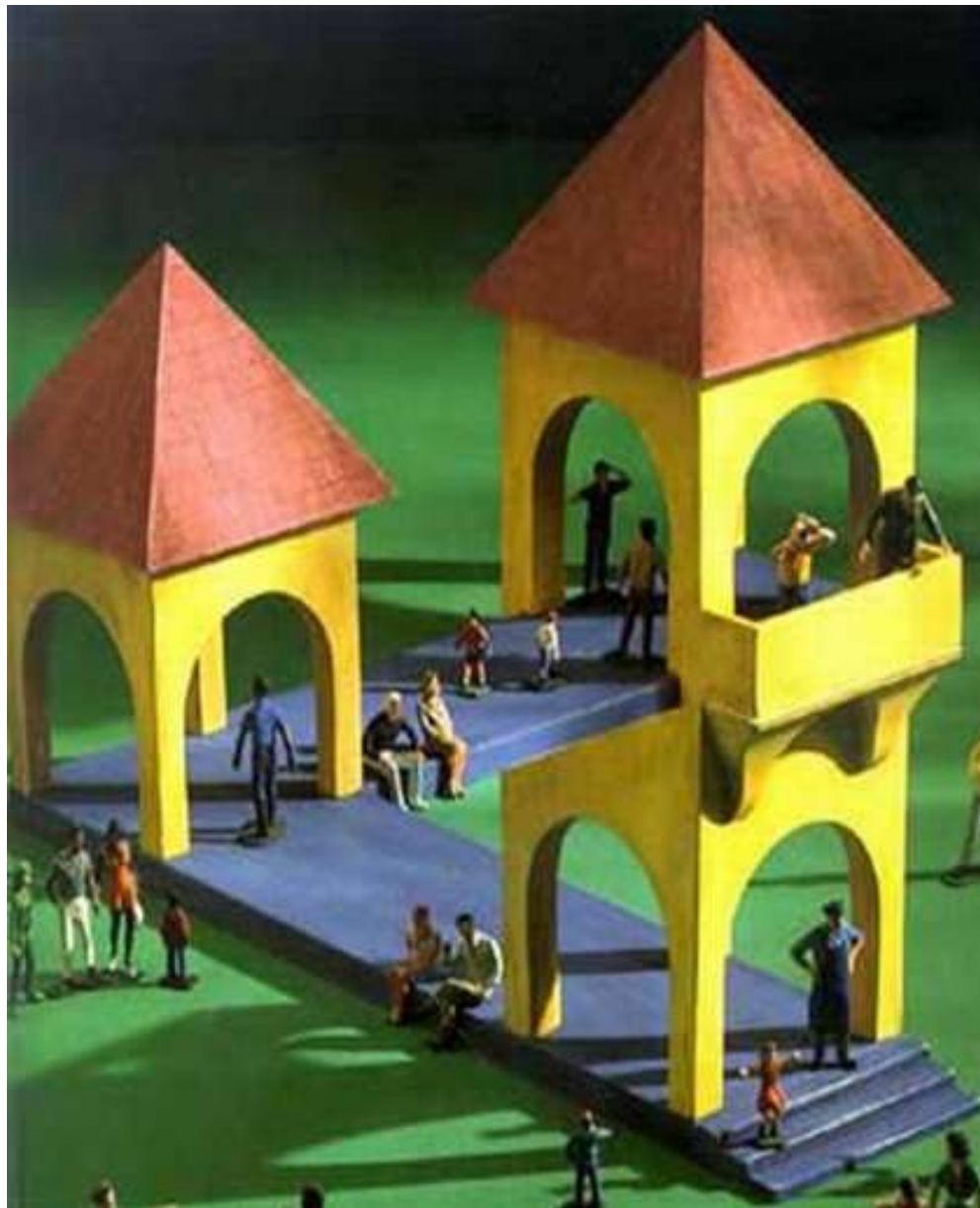

**Extraña construcción**



**¿Cuál es el final del recorrido del agua?**

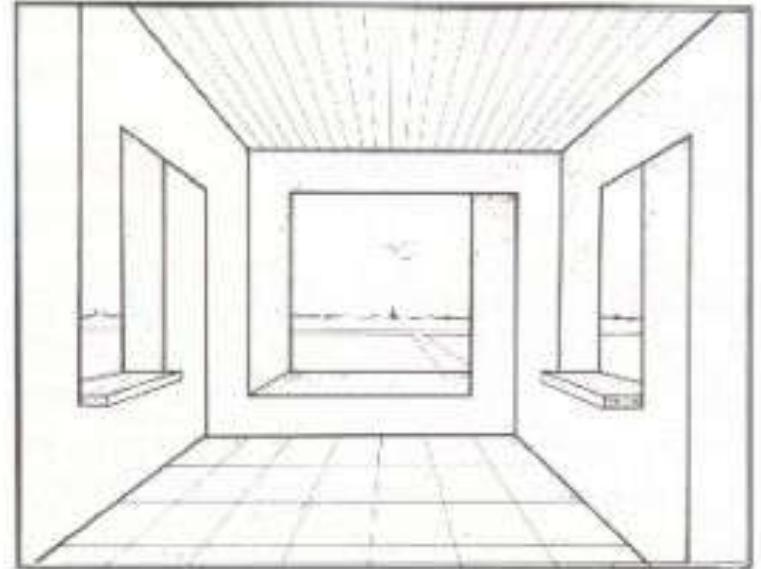
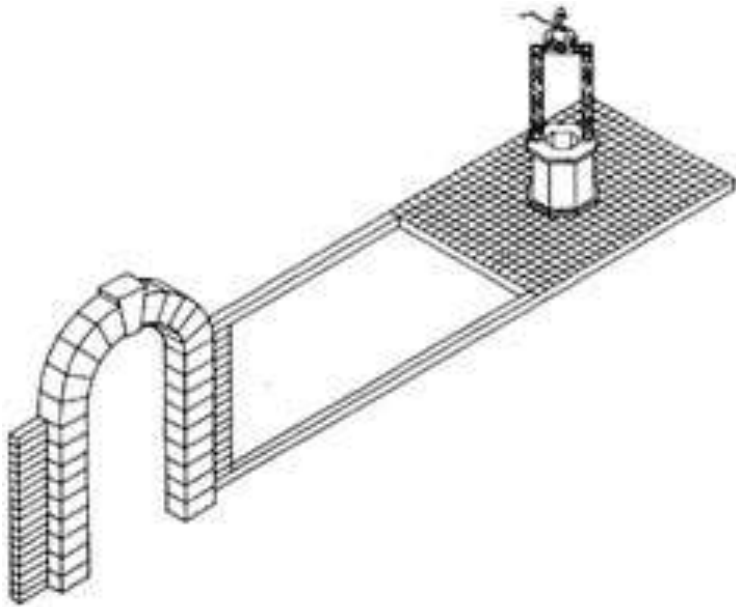

**Perspectivas imposibles...**



**Extraño ajedrez...**



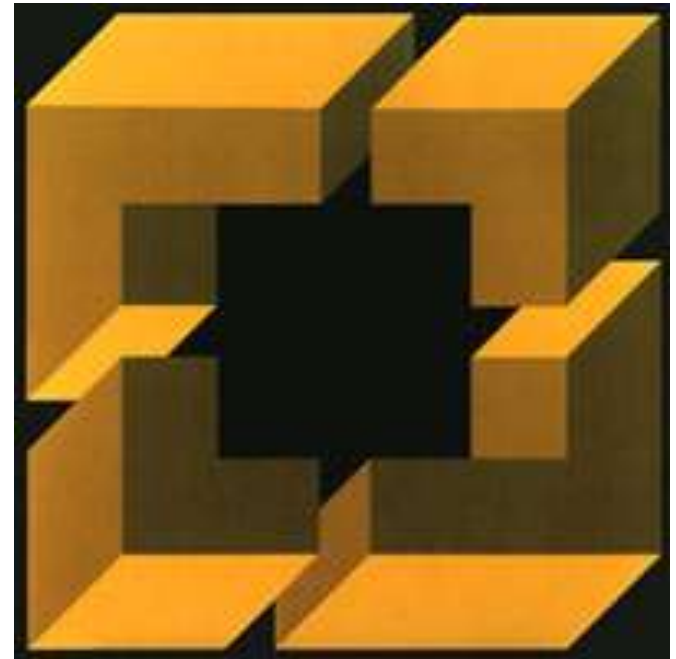
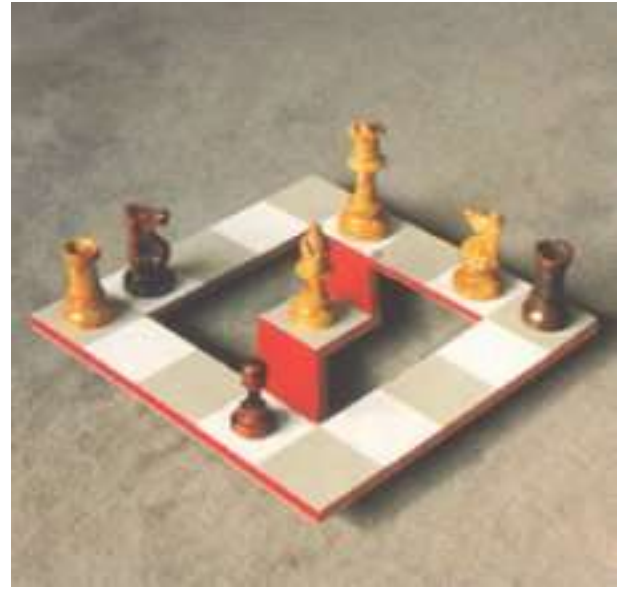
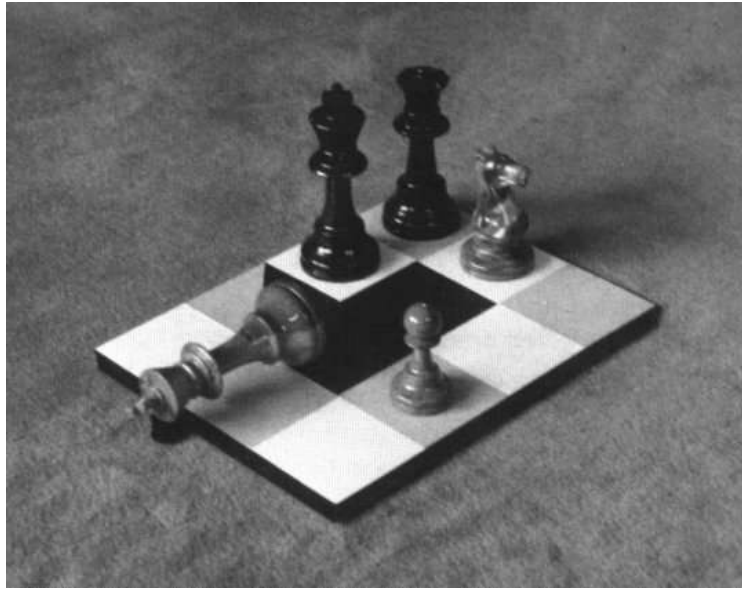

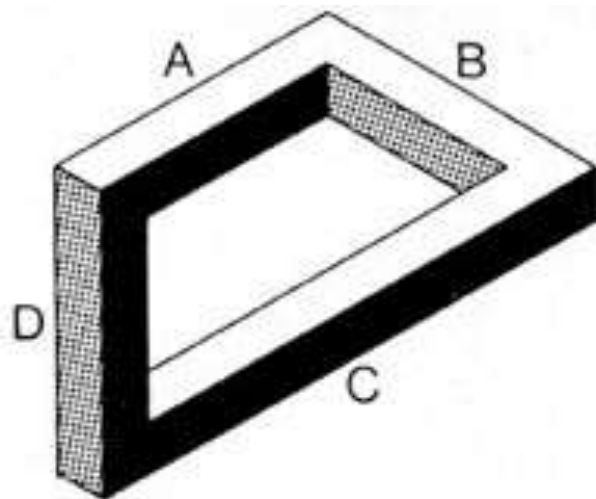
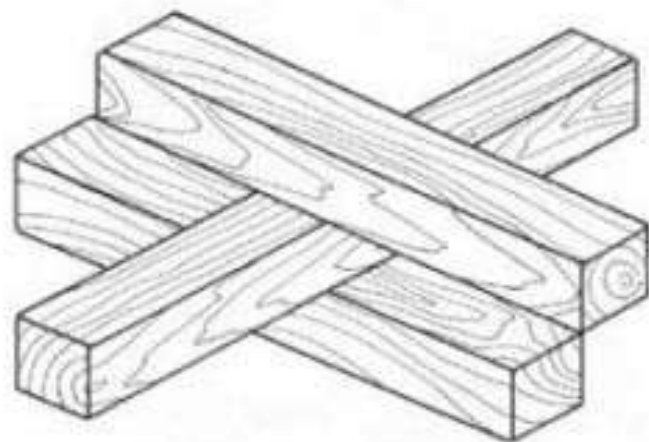

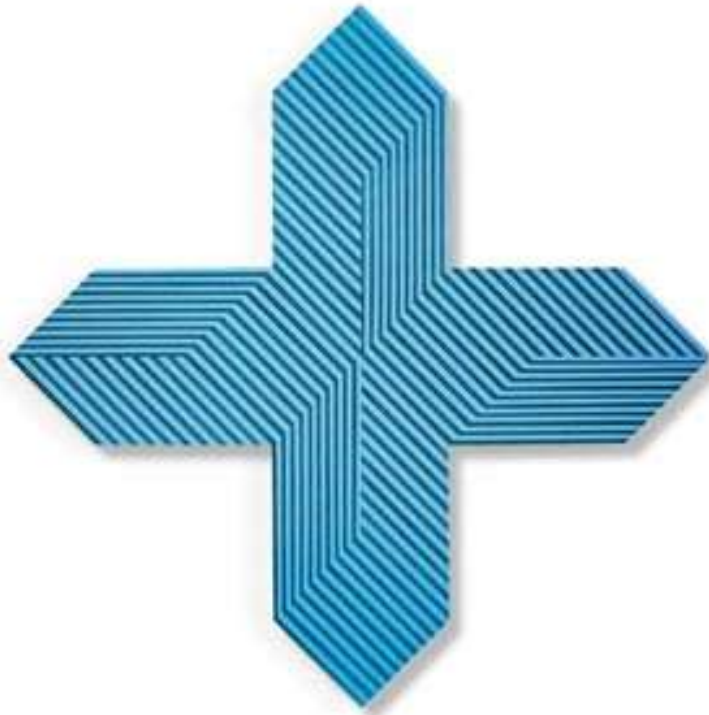
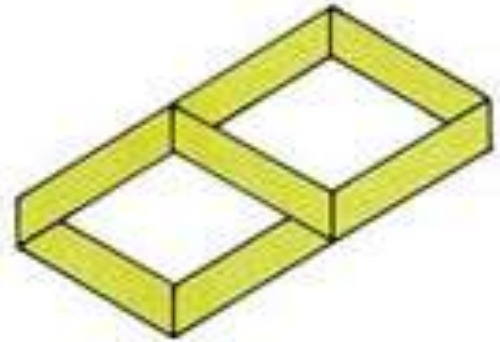
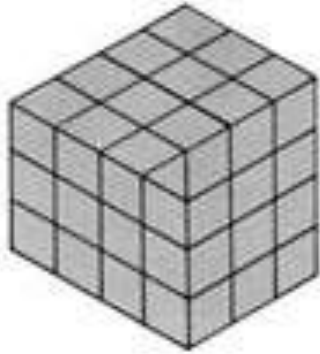



**Extraño aparcamiento...**



**El Audi fantástico**



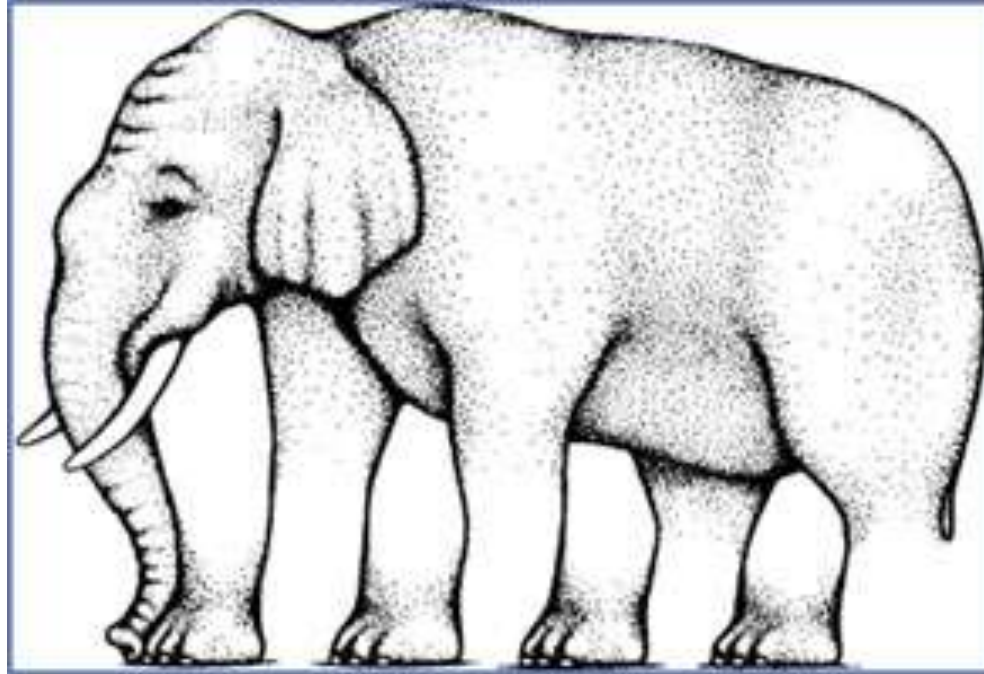

**Cuenta las patas de este elefante..., si es que puedes...**

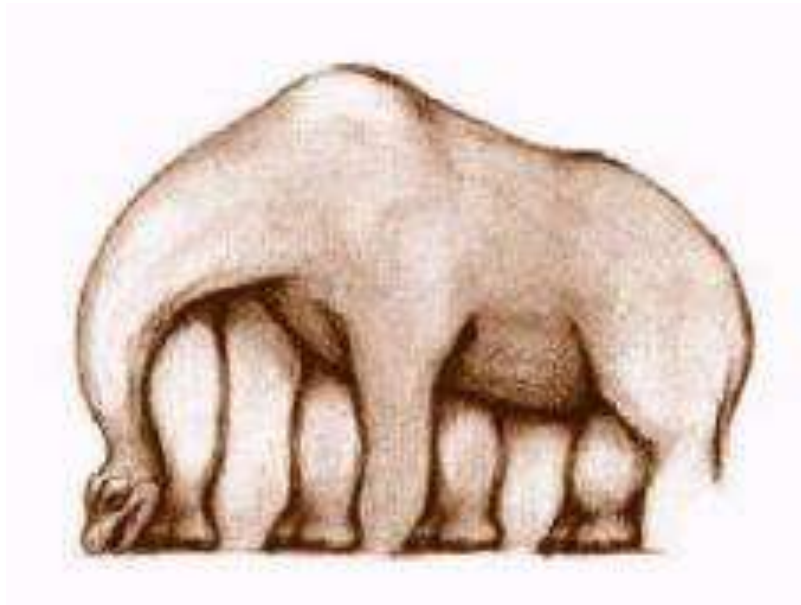

**¿Cuántas patas tiene este dinosaurio?...**



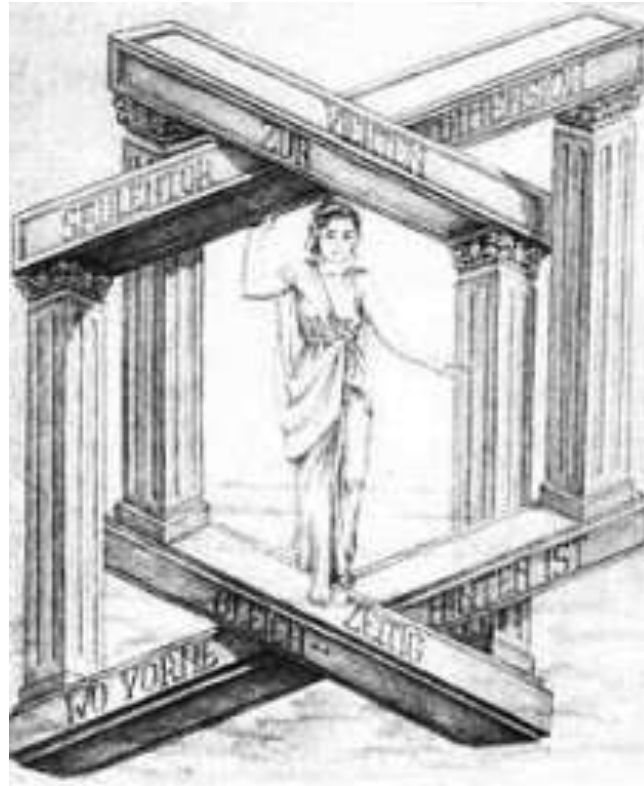

**Extraña geometría...**

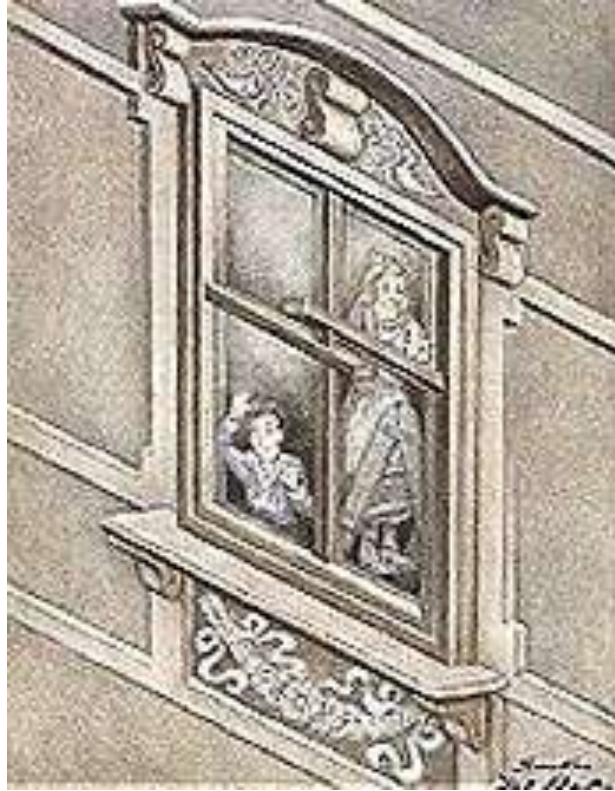

**Extraña ventana, con dos orientaciones...**

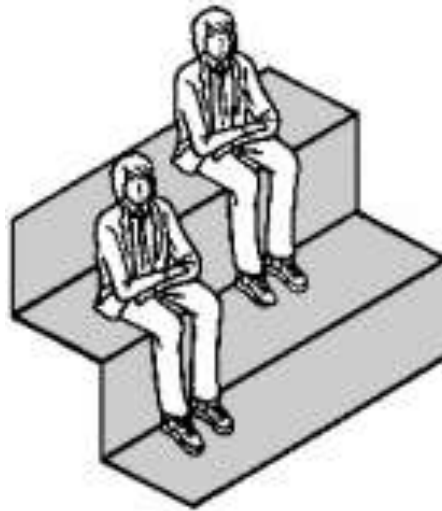

**Siéntate, si puedes...**



**Ruedas imposibles**

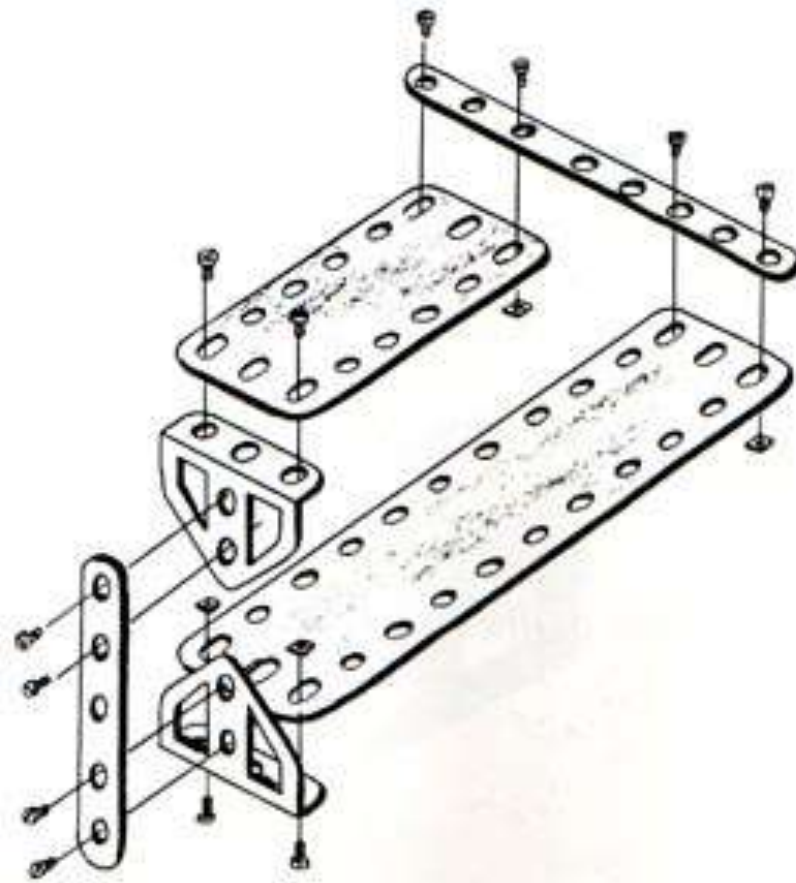

**¿Serías capaz de montar este artilugio?...**



**Lo vas a tener un poco difícil si buscas un tornillo para esta rosca...**



**Contradicciones perceptivas**

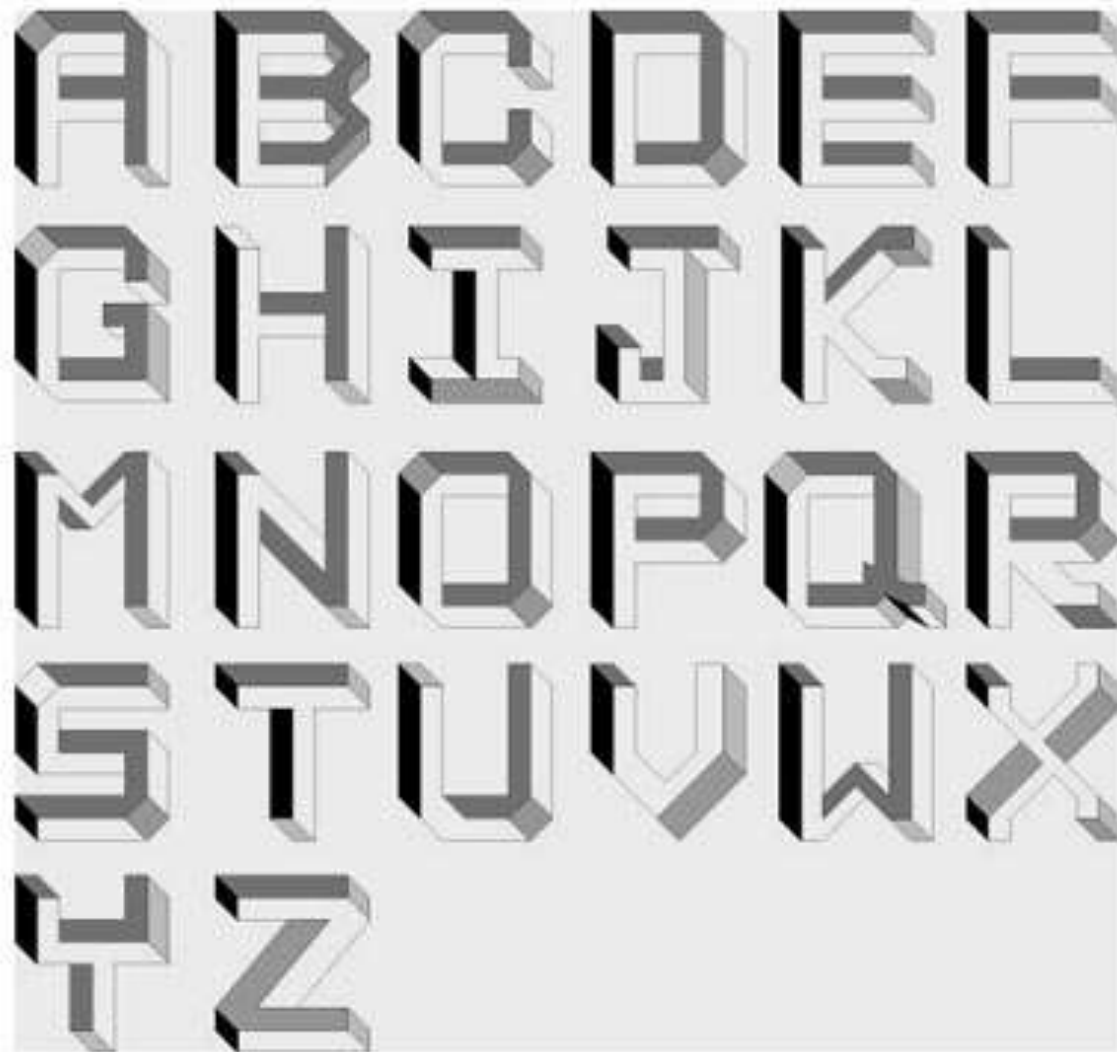

**Letras imposibles...**



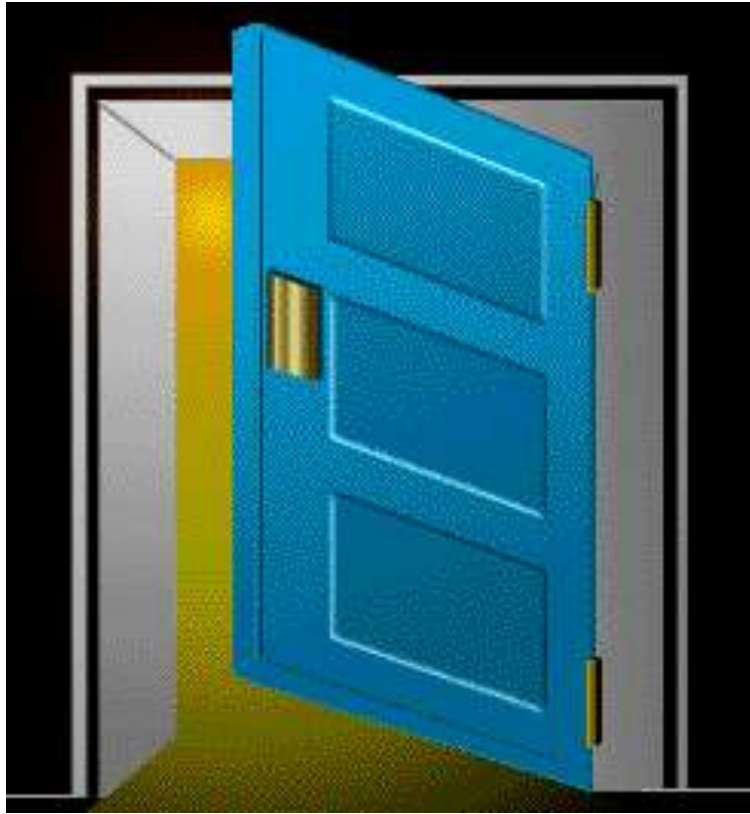

**¿Se abre o se cierra?**

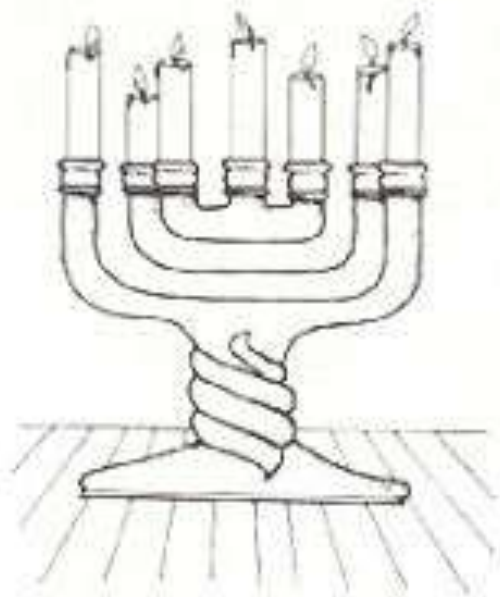

**Falso candelabro**



**Arcos esquivos...**



**Incongruencias**